

### Classe A :

- > Visibilité à 80 m
- > Matière Conformable
- > Minimum autorisé par la réglementation



### Classe B :

- > Visibilité au delà de 500 m
- > Conformabilité
- > Enlevabilité
- > Durabilité



**Sarr TPESC-B 14037 3M**

Article 122 – partie C : « les véhicules travaillant habituellement sur la chaussée doivent porter une signalisation complémentaire conforme à l'arrêté du 20 janvier 1987 » :

- > Surface mini à l'arrière : 2 bandes horizontales + 2 bandes verticales = 0,32 m<sup>2</sup>
- > Surface mini latérale : 2 bandes horizontales = 0,16 m<sup>2</sup> par côté
- > Surface mini à l'avant : 2 bandes horizontales = 0,16 m<sup>2</sup>

## MASTER H2 - À PARTIR DE 2024

STANDARD

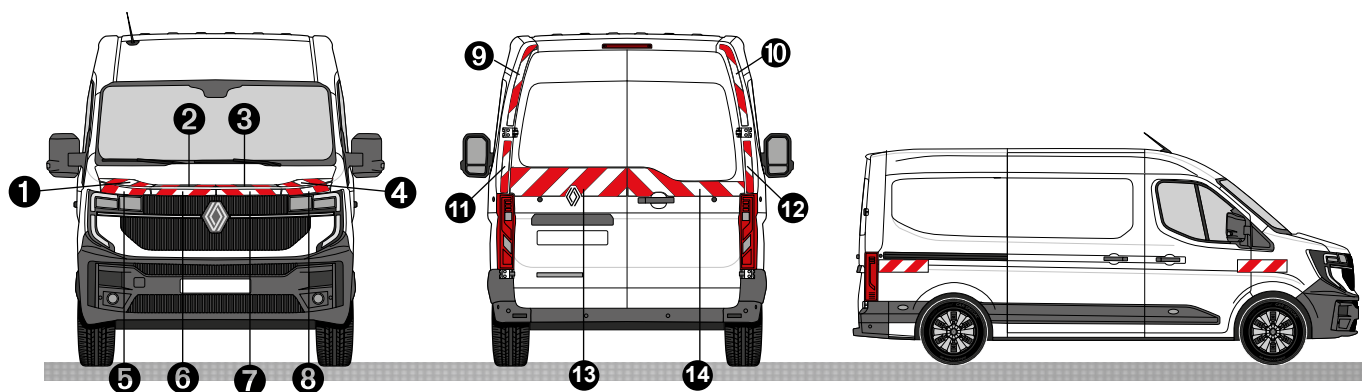
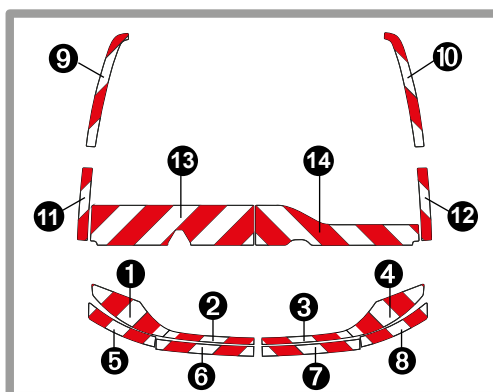

	CLASSE A	CLASSE B
Av	79 3M RE 205 AV	79 3M RE 206 AV
Av + Ar	79 3M RE 205	79 3M RE 206
Standard (Av + Ar + latéral)	79 3M RE 205 ST	79 3M RE 206 ST

## MASTER H1 - ANNÉES 2019 À 2023

STANDARD

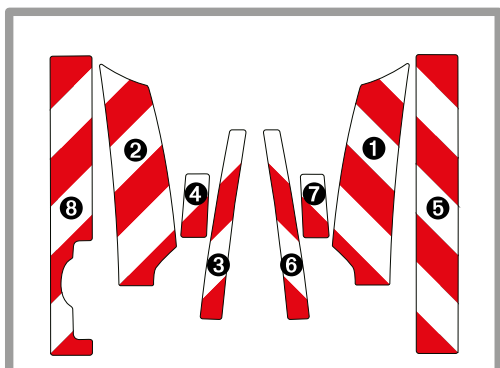

Total

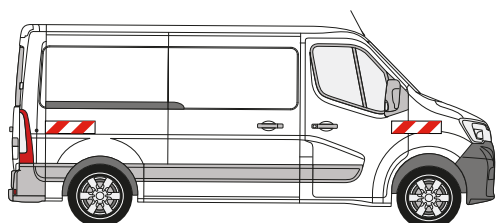
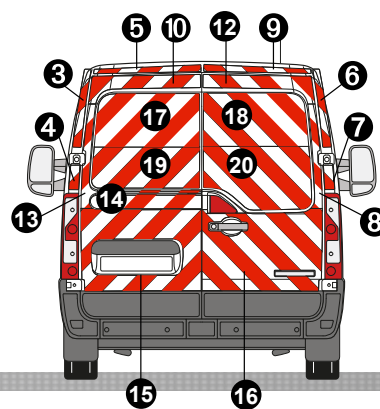
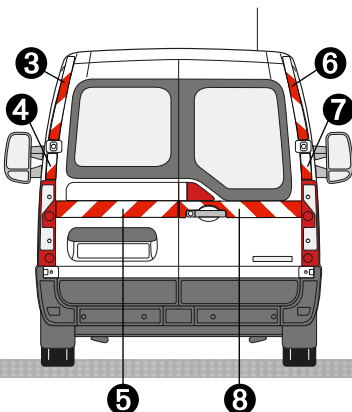
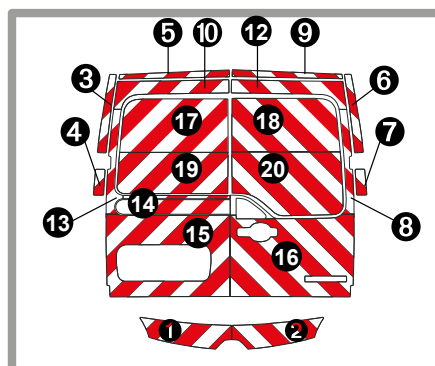

	CLASSE A	CLASSE B
Av	79 3M RE 165 AV	79 3M RE 166 AV
Av + Ar	79 3M RE 167	79 3M RE 168
Standard (Av + Ar + latéral)	79 3M RE 167 ST	79 3M RE 168 ST
TOTAL Tôlé (Av + Ar total + latéral)	79 3M RE 167 TT	79 3M RE 168 TT
Maxi (Av + Ar + latéral maxi)	79 3M RE 167 MX	79 3M RE 168 MX

## MASTER H2 - ANNÉES 2019 À 2023

STANDARD



TOTAL

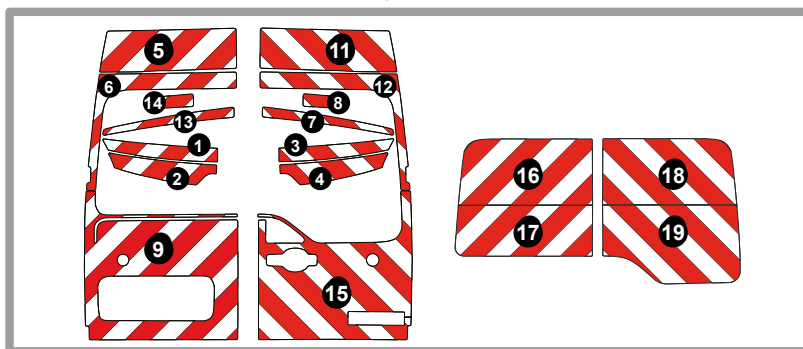

STANDARD

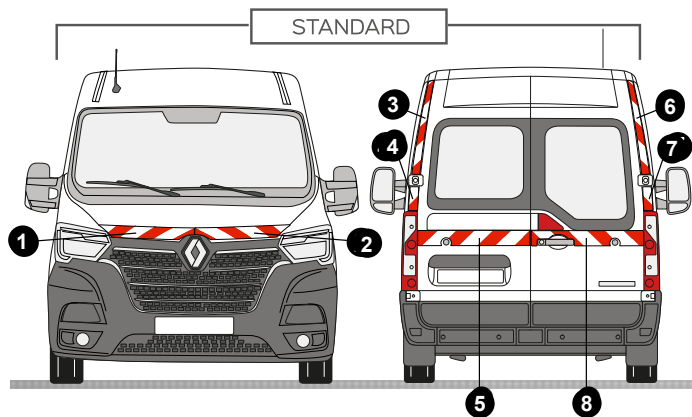

TOTAL

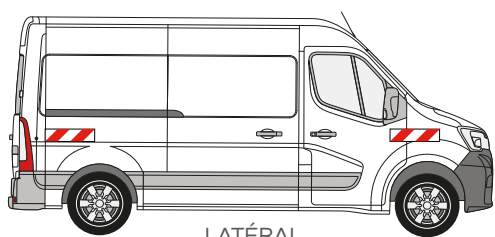
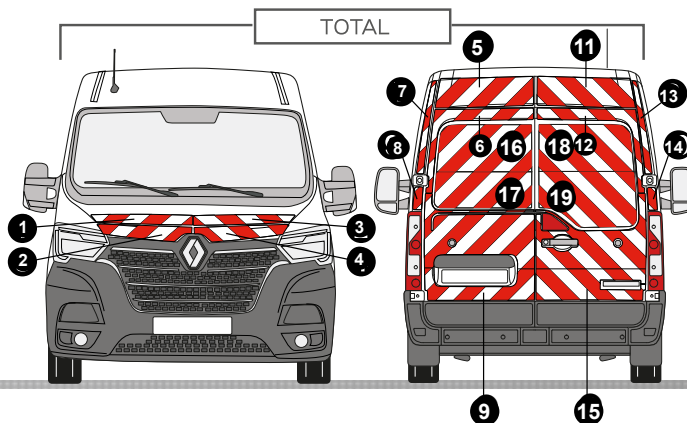

LATÉRAL

	CLASSE A	CLASSE B
Av	79 3M RE 165 AV	79 3M RE 166 AV
Av + Ar	79 3M RE 165	79 3M RE 166
Standard (Av + Ar + latéral)	79 3M RE 165 ST	79 3M RE 166 ST
TOTAL vitré (Av + Ar total + latéral)	79 3M RE 165 TT	79 3M RE 166 TT
TOTAL Tôlé (Av + Ar total + latéral)	79 3M RE 193 TT	79 3M RE 194 TT

## MASTER H1 - ANNÉES 2014 À 2019

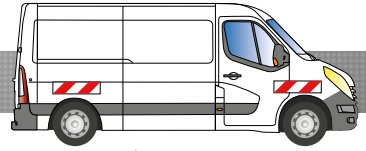
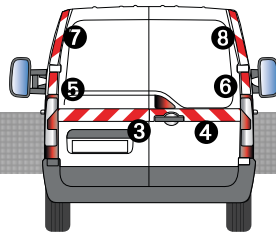
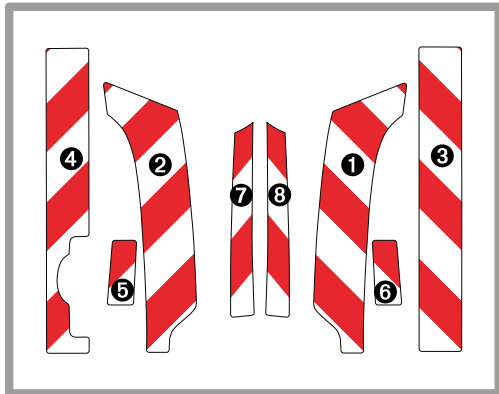

Latéral standard

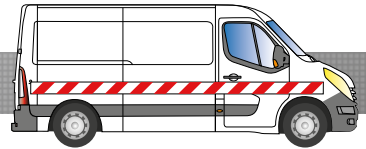
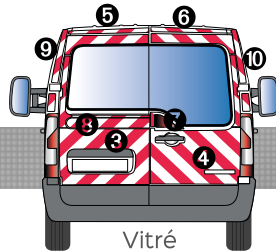
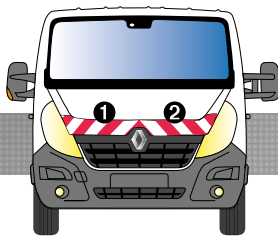
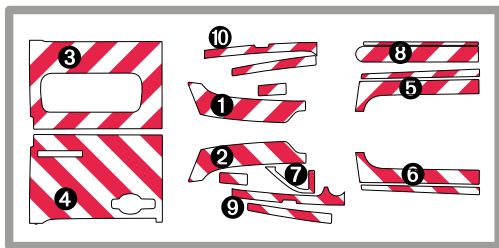

Vitré

Latéral Maxi

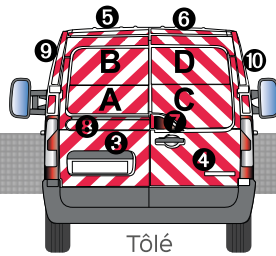
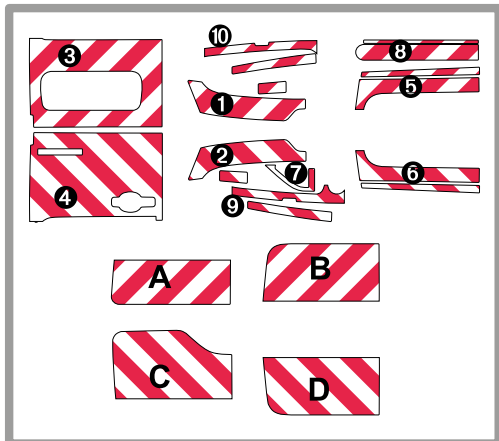

Tôle

Latéral Maxi

	CLASSE A	CLASSE B
Av	79 3M RE 127 AV	79 3M RE 128 AV
Av + Ar	79 3M RE 127	79 3M RE 128
Standard (Av + Ar + latéral)	79 3M RE 127 ST	79 3M RE 128 ST
TOTAL Vitré (Av + Ar total + latéral maxi)		79 3M RE 128 MX
TOTAL Tôle (Av + Ar total + latéral maxi)		79 3M RE 136 MX

## MASTER H2 - ANNÉES 2014 À 2019

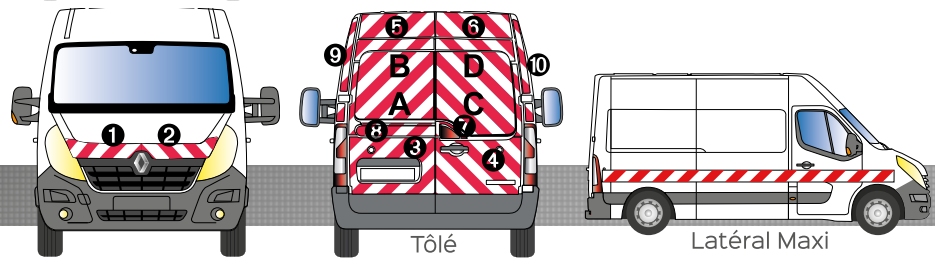
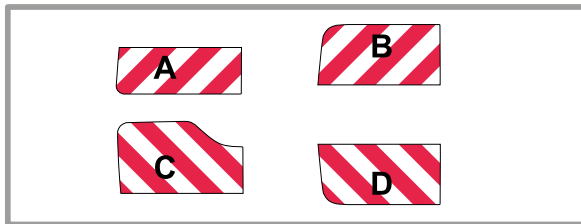
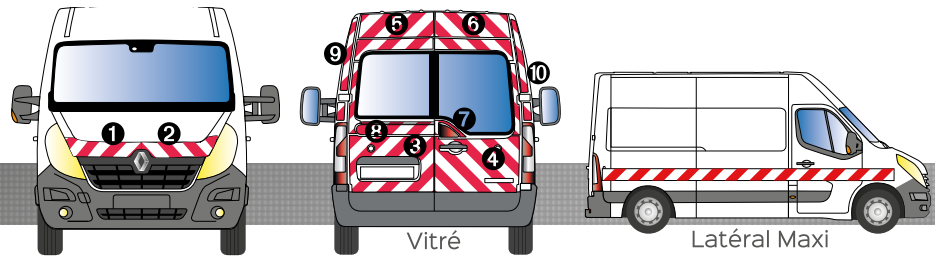
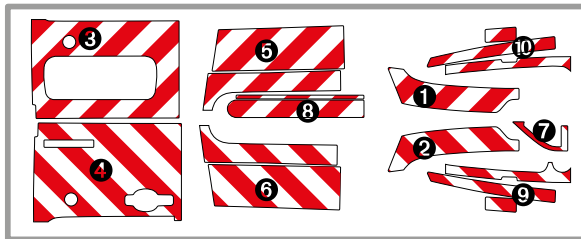
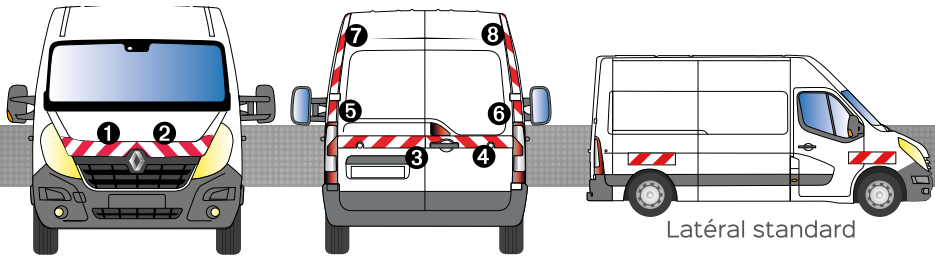
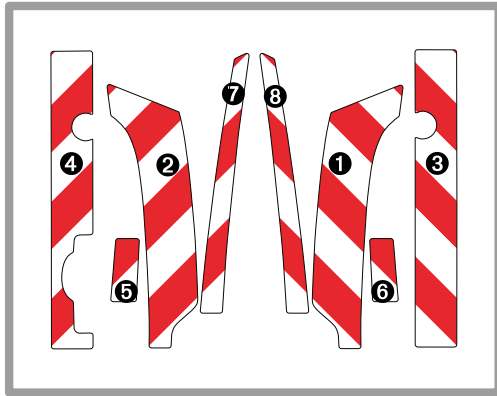

	CLASSE A	CLASSE B
Av + Ar	79 3M RE 125	79 3M RE 126
Standard (Av + Ar + latéral)	79 3M RE 125 ST	79 3M RE 126 ST
TOTAL vitré (Av + Ar total + latéral maxi)		79 3M RE 126 MX
TOTAL vitré (Av + Ar total + latéral)		79 3M RE 126 TT
TOTAL Tôle (Av + Ar total + latéral maxi)		79 3M RE 134 MX

## MASTER H1 - ANNÉES 2010 À 2013

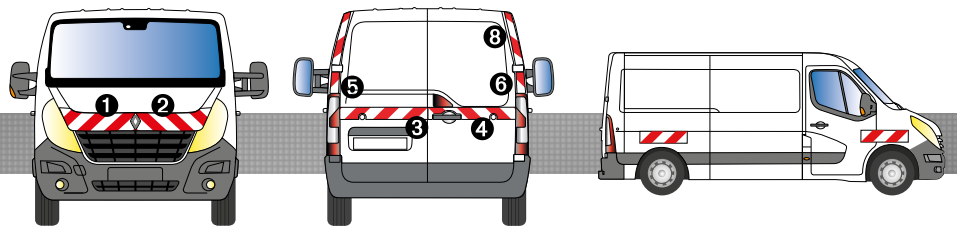
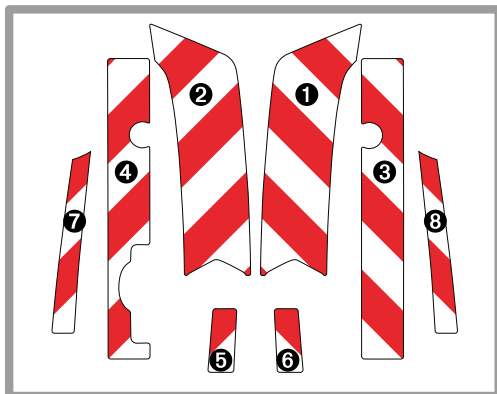

	CLASSE A	CLASSE B
Av + Ar	79 3M RE 097	79 3M RE 098
Standard (Av + Ar + latéral)	79 3M RE 097 ST	79 3M RE 098 ST

## MASTER H2 - ANNÉES 2010 À 2013

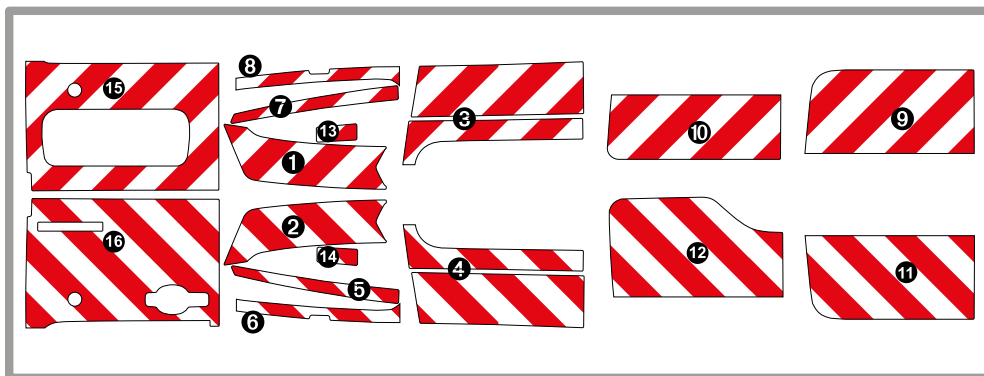
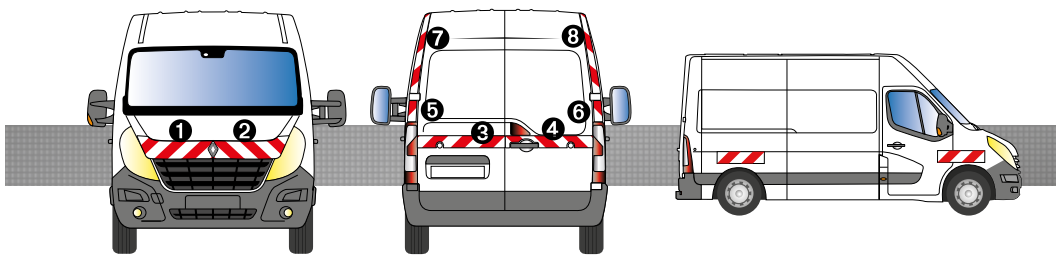
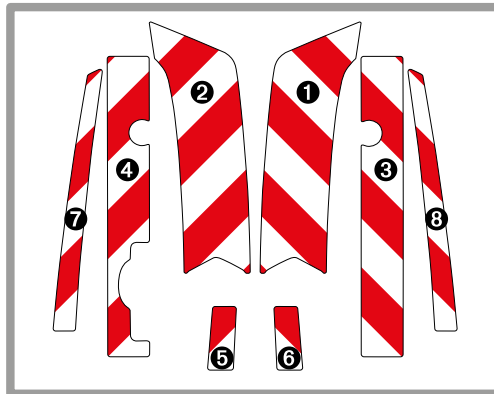

KIT TOTAL

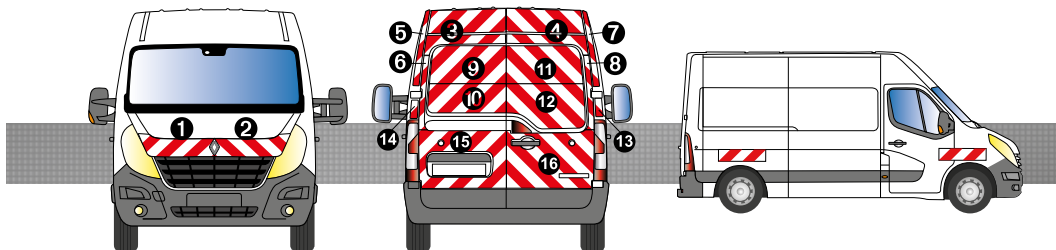

	CLASSE A	CLASSE B
Av + Ar	79 3M RE 093	79 3M RE 094
Standard (Av + Ar + latéral)	79 3M RE 093 ST	79 3M RE 094 ST
TOTAL tôle (Av + Ar total + latéral)		79 3M RE 094 TT

## Master 2 PORTES RÉHAUSSÉ à partir de 2003

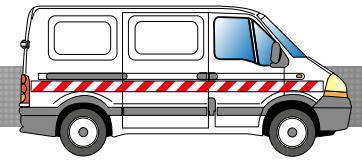
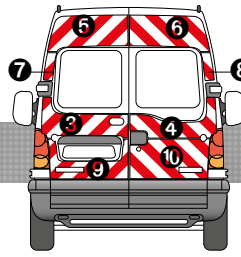
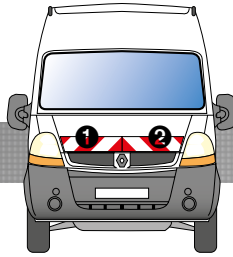
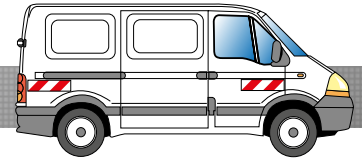
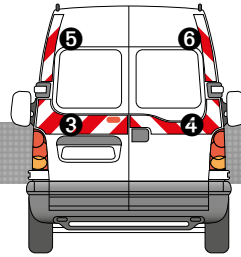
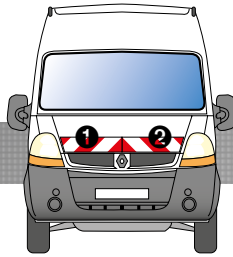
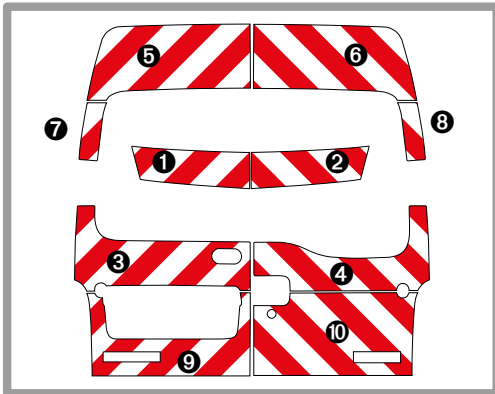
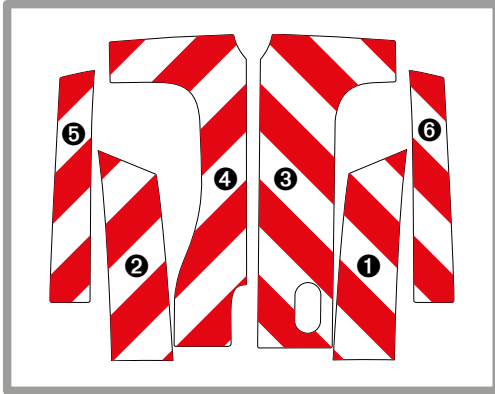

	CLASSE A	CLASSE B
Av + Ar	79 3M RE 033	79 3M RE 034
Standard (Av + Ar + latéral)	79 3M RE 033 ST	79 3M RE 034 ST
MX (Av + ArTotal + latéral MAXI)	79 3M RE 033 MX	79 3M RE 034 MX

## Master 2 PORTES H3 à partir de 2003

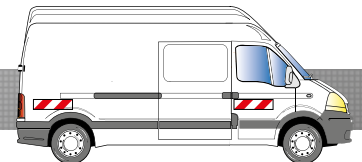
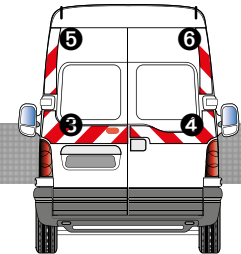
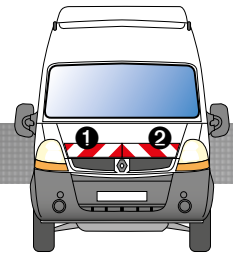
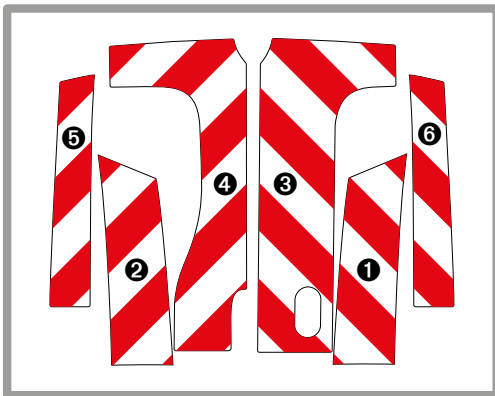

	CLASSE A	CLASSE B
Av + Ar	79 3M RE 033	79 3M RE 034
Standard (Av + Ar + latéral)	79 3M RE 033 ST	79 3M RE 034 ST

## Master 2 PORTES RÉHAUSSÉ de 1997 à 2003

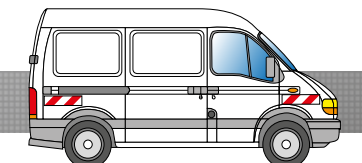
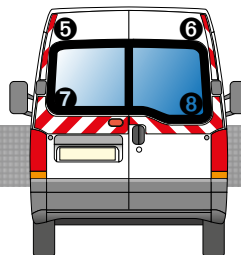
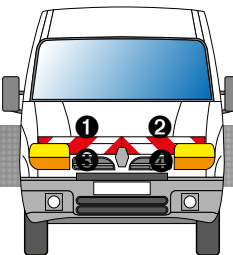
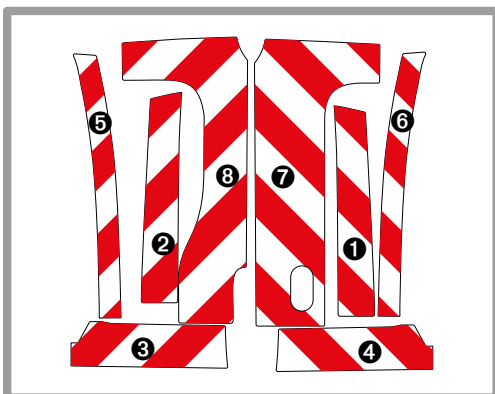

	CLASSE A	CLASSE B
Av + Ar	79 3M RE 023	79 3M RE 024
Standard (Av + Ar + latéral)	79 3M RE 23 ST	79 3M RE 024 ST

## Master 2 PORTES PLAT à partir de 2003

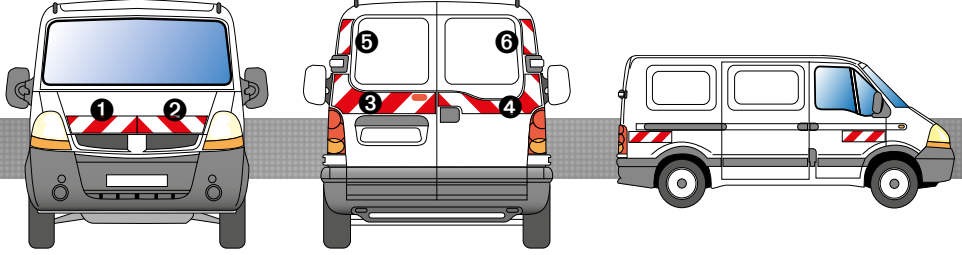
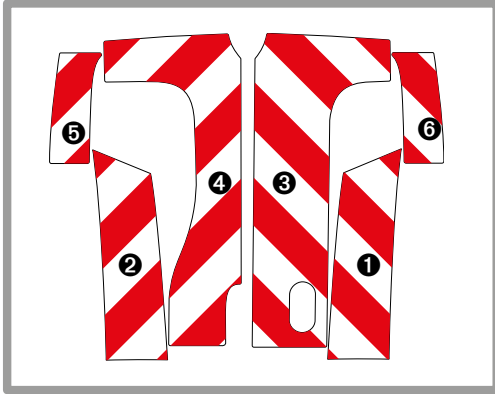

	CLASSE A	CLASSE B
Av	79 3M RE 031 AV	79 3M RE 032 AV
Av + Ar	79 3M RE 031	79 3M RE 032
Standard (Av + Ar + latéral)	79 3M RE 031 ST	79 3M RE 032 ST

## Master 2 PORTES PLAT de 1997 à 2003

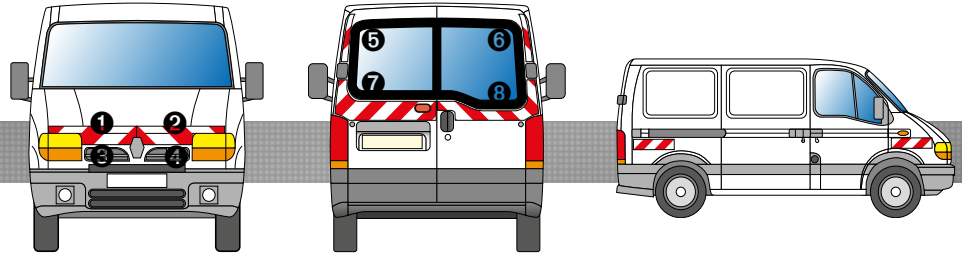
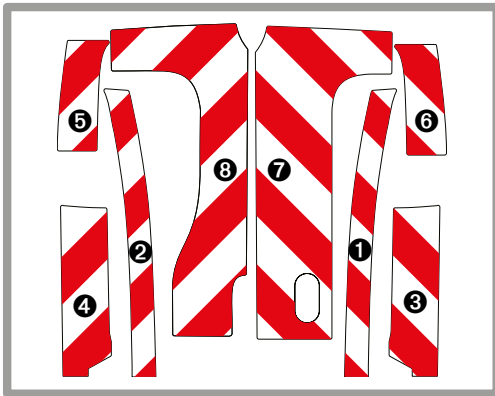

	CLASSE A	CLASSE B
Av	79 3M RE 005 AV	79 3M RE 006 AV
Av + Ar	79 3M RE 005	79 3M RE 006
Standard (Av + Ar + latéral)	79 3M RE 005 ST	79 3M RE 006 ST